

surface mounting appliance inlet - with external fixing

Product description	
Order number	24404
EAN/pcs	4024941244046
Product Group	wall mounting appliance inlet Quick-Connect
Amperage	32A
Poles	4p (3P+PE)
Earth 'Clock' Position	9 h
Voltage	200 up to 250V
Frequenz	50 and 60Hz
Protection	IP44
Color code	blue RAL 5015
Connection Design	screwless spring-clamp technology with box terminals
Max. conductor	6,0 mm ²



Further Information	
Cable entry	top entry M25
Packaging	92x94 mm (HxW)
Additional technical information	The cable entry is one at top open and one at bottom closed

Material	
Material of Enclosure	Polyamide
Contact / Contact Carrier	contact carrier made of polyamide, the contacts are brass
Weight/pcs	0.258 kg

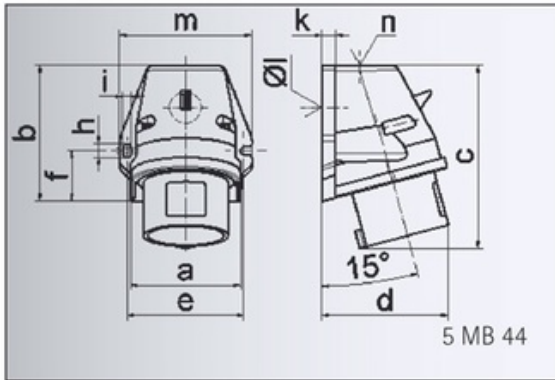

Ampere	16	16	16	32	32	32
Polzahl	3	4	5	3	4	5
a	59,5	72,4	72,4	79,1	79,1	79,1
b	90,0	90,0	90,0	92,0	92,0	92,0
c	120,0	120,0	122,0	134,0	134,0	134,0
d	72,0	84,0	84,0	89,0	89,0	89,0
e	62,0	77,0	77,0	84,0	84,0	84,0
f	33,5	33,5	33,5	30,0	30,0	30,0
h	9,0	9,0	9,0	9,0	9,0	9,0
i	5,5	5,5	5,5	5,5	5,5	5,5
k	8,0	9,0	9,0	9,0	9,0	9,0
l ø	21,0	21,0	21,0	21,0	21,0	21,0
m	72,0	87,0	87,0	94,0	94,0	94,0
n	M 20	M 25	M 25	M 25	M 25	M 25
Leiter mm ² min	1	1	1	2,5	2,5	2,5
Leiter mm ² max	2,5	2,5	2,5	6	6	6