

# Data sheet

Order number: 303-TLS

TLS connector Multi-Grip cable gland

EAN/pcs	<b>4024941192316</b>
Ampere	<b>16A</b>
Poles	<b>5p (3p+N+PE)</b>
Earth 'Clock' Position	<b>6 h</b>
Voltage	<b>200/346 up to 240/415V</b>
Frequency	<b>50 and 60Hz</b>
Protection	<b>IP44</b>
Color code	<b>red RAL 3000</b>
Connection Design	<b>screw terminal</b>
Contact	<b>contact carrier made of polyamide, the contacts are brass</b>
Weight/pcs	<b>0,180 kg</b>
Packaging unit	<b>100 pc/pcs</b>
Material of enclosure	<b>Polyamide</b>

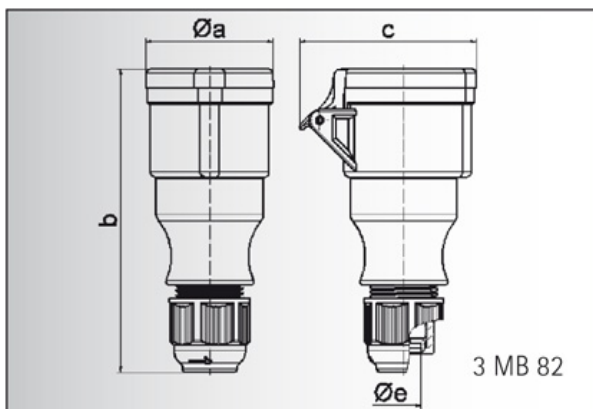

Ampere	16	16	16	32	32	32
Polzahl	3	4	5	3	4	5
a Ø	51,0	58,0	65,0	67,0	67,0	73,0
b	145,0	148,0	156,0	185,0	185,0	185,0
c	74,0	84,0	90,0	94,0	94,0	102,0
e Ø	18,0	18,0	18,0	23,0	23,0	23,0
Leiter mm <sup>2</sup> min	1	1	1	2,5	2,5	2,5
Leiter mm <sup>2</sup> max	2,5	2,5	2,5	6	6	6

**Bals Elektrotechnik GmbH & Co. KG**

D-57399 Kirchhundem - Albaum

phone: +49(0)2723/771-0 fax: +49(0)2723/771-177

email: info@bals.com www.bals.com

date: 03.05.2016