

Data sheet

Order number: 1323

GT panel mounting socket outlet straight

EAN/pcs	4024941013239
Ampere	16A
Poles	4p (3P+PE)
Earth 'Clock' Position	9 h
Voltage	200 up to 250V
Frequency	50 and 60Hz
Protection	IP44
Color code	blue RAL 5015
Connection Design	screw terminal
Contact	contact carrier made of polyamide, the contacts are brass
Weight/pcs	0,138 kg
Packaging unit	10 pc/pcs
Material of enclosure	Polyamide

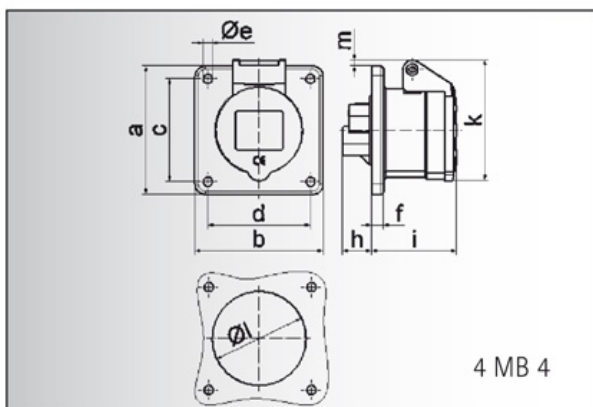

Ampere	16	16	16	32	32	32
Polzahl	3	4	5	3	4	5
a	75,0	75,0	75,0	75,0	75,0	75,0
b	75,0	75,0	75,0	75,0	75,0	75,0
c	60,0	60,0	60,0	60,0	60,0	60,0
d	60,0	60,0	60,0	60,0	60,0	60,0
e ø	5,5	5,5	5,5	5,5	5,5	5,5
f	7,0	7,0	7,0	8,0	8,0	8,0
h	17,0	26,0	17,0	36,0	36,0	19,0
i	51,0	53,0	53,0	62,0	62,0	62,0
k	70,0	80,0	85,0	90,0	90,0	98,0
l ø	45,0	45,0	55,0	60,0	60,0	60,0
m	3,5	7,0	11,5	12,0	12,0	17,0
Leiter mm ² min	1,5	1,5	1,5	2,5	2,5	2,5
Leiter mm ² max	4	4	4	10	10	10

Bals Elektrotechnik GmbH & Co. KG

D-57399 Kirchhundem - Albaum

phone: +49(0)2723/771-0 fax: +49(0)2723/771-177

email: info@bals.com www.bals.com

date: 03.05.2016