

# Data sheet

Order number: 204-TLS

TLS plug Multi-Grip cable gland

EAN/pcs **4024941192293**

Ampere **32A**

Poles **5p (3p+N+PE)**

Earth 'Clock' Position **6 h**

Voltage **200/346 up to 240/415V**

Frequency **50 and 60Hz**

Protection **IP44**

Color code **red RAL 3000**

Connection Design **screw terminal**

Contact **contact carrier made of polyamide, the contacts are brass**

Weight/pcs **0,250 kg**

Packaging unit **100 pc/pcs**

Material of enclosure **Polyamide**

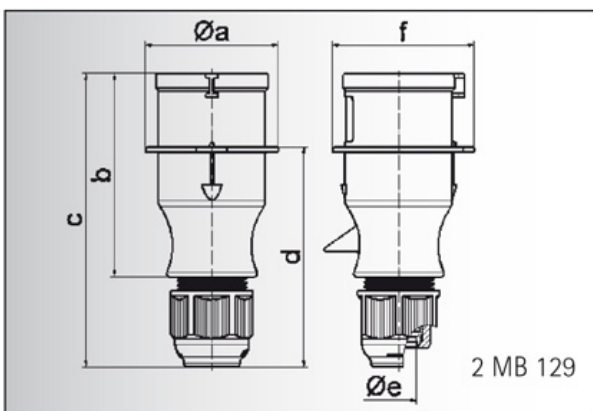
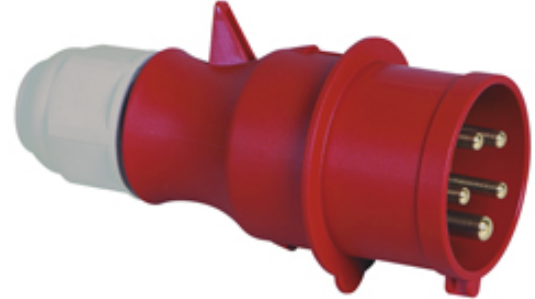

Ampere	16	16	16	32	32	32
Polzahl	3	4	5	3	4	5
a ø	54,0	60,0	66,0	71,0	71,0	80,0
b	94,5	98,0	101,0	115,0	115,0	119,0
c	138,0	142,0	145,0	170,0	170,0	174,0
d	101,5	105,5	108,5	124,0	124,0	128,0
e ø	18,0	18,0	18,0	23,0	23,0	23,0
f	56,6	64,0	71,0	76,0	76,0	85,0
Leiter mm <sup>2</sup> min	1	1	1	2,5	2,5	2,5
Leiter mm <sup>2</sup> max	2,5	2,5	2,5	6	6	6

**Bals Elektrotechnik GmbH & Co. KG**

D-57399 Kirchhundem - Albaum

phone: +49(0)2723/771-0 fax: +49(0)2723/771-177

email: info@bals.com

www.bals.com

date: 03.05.2016