

Data sheet

Order number: 16097

QC wall mounting socket outlet, switched, interlocked

EAN/pcs **4024941160971**

Ampere **32A**

Poles **3p (2P+PE)**

Earth 'Clock' Position **6 h**

Voltage **200 up to 250V**

Frequency **50 and 60Hz**

Protection **IP44**

Color code **blue RAL 5015**

Connection Design **screwless spring terminals as cage clamp with Kontext-contact**

Contact **contact carrier made of high temperature resistant material, contacts are brass nickel plated**

Weight/pcs **1,160 kg**

Packaging unit **1 pc/pcs**

Material of enclosure **Polycarbonate**

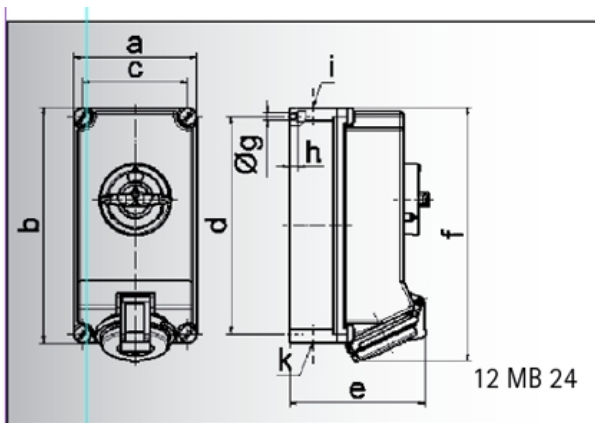

Ampere	16	16	32	32	32
Polzahl	4	5	3	4	5
a	118,0	118,0	118,0	118,0	118,0
b	225,0	225,0	225,0	225,0	225,0
c	101,0	101,0	101,0	101,0	101,0
d	208,0	208,0	208,0	208,0	208,0
e	126,0	134,0	137,0	137,0	144,0
f	242,0	242,0	251,0	251,0	251,0
g ø	6,5	6,5	6,5	6,5	6,5
h	8,0	8,0	8,0	8,0	8,0
i	2 x M 25	2 x M 25	2 x M 25	2 x M 25	2 x M 25
k	2 x M 25	2 x M 25	2 x M 25	2 x M 25	2 x M 25

Bals Elektrotechnik GmbH & Co. KG

D-57399 Kirchhundem - Albaum

phone: +49(0)2723/771-0 fax: +49(0)2723/771-177

email: info@bals.com www.bals.com

date: 03.05.2016