

panel mounting appliance inlet, straight - flange 85x85, fixing centers 70x70

Product description

Order number	28100
EAN/pcs	4024941281003
Product Group	GT panel mounting appliance inlet, straight
Amperage	16A
Poles	4p (3P+PE)
Earth 'Clock' Position	6 h
Voltage	380 up to 415V
Frequenz	50 and 60Hz
Protection	IP44
Color code	red RAL 3000
Connection Design	screw terminal
Max. conductor	2,5 mm ²



Further Information

Additional technical information	A retaining device to match the hinged cover of the connector must be provided to ensure the latching feature
----------------------------------	---

Material

Material of Enclosure	Polyamide
Contact / Contact Carrier	contact carrier made of polyamide, the contacts are brass
Packaging unit	10 ST

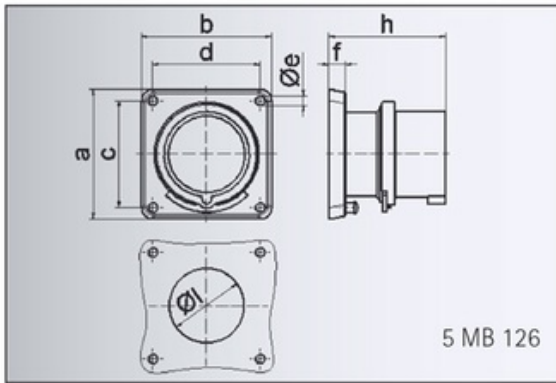

Ampere	16	16	16	32	32	32
Polzahl	3	4	5	3	4	5
a	85,0	85,0	85,0	85,0	85,0	85,0
b	85,0	85,0	85,0	85,0	85,0	85,0
c	70,0	70,0	70,0	70,0	70,0	70,0
d	70,0	70,0	70,0	70,0	70,0	70,0
e ø	6,3	6,3	6,3	6,3	6,3	6,3
f	11,0	11,0	11,0	11,0	11,0	11,0
h	75,5	75,0	76,5	85,0	85,0	85,0
l ø	49,0	49,0	49,0	49,0	49,0	49,0
Leiter mm ² min	1	1	1	2,5	2,5	2,5
Leiter mm ² max	2,5	2,5	2,5	6	6	6