

# panel mounting appliance inlet, straight - flange 85x85, fixing centers 70x70

Product description	
Order number	28108
EAN/pcs	4024941281089
Product Group	GT panel mounting appliance inlet, straight
Amperage	32A
Poles	5p (3p+N+PE)
Earth 'Clock' Position	6 h
Voltage	200/346 up to 240/415V
Frequenz	50 and 60Hz
Protection	IP44
Color code	red RAL 3000
Connection Design	screw terminal
Max. conductor	6,0 mm <sup>2</sup>



Further Information	
Additional technical information	A retaining device to match the hinged cover of the connector must be provided to ensure the latching feature

Material	
Material of Enclosure	Polyamide
Contact / Contact Carrier	contact carrier made of polyamide, the contacts are brass
Weight/pcs	0.240 kg
Packaging unit	10 ST

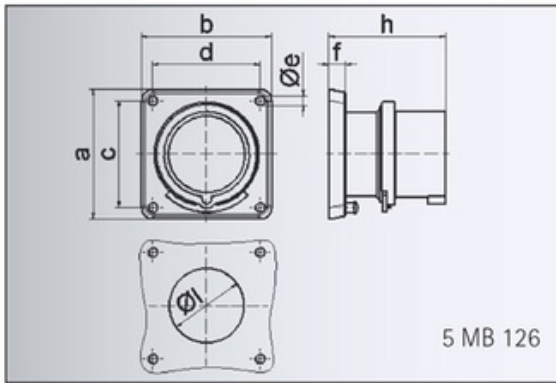

Ampere	16	16	16	32	32	32
Polzahl	3	4	5	3	4	5
a	85,0	85,0	85,0	85,0	85,0	85,0
b	85,0	85,0	85,0	85,0	85,0	85,0
c	70,0	70,0	70,0	70,0	70,0	70,0
d	70,0	70,0	70,0	70,0	70,0	70,0
e ø	6,3	6,3	6,3	6,3	6,3	6,3
f	11,0	11,0	11,0	11,0	11,0	11,0
h	75,5	75,0	76,5	85,0	85,0	85,0
l ø	49,0	49,0	49,0	49,0	49,0	49,0
Leiter mm <sup>2</sup> min	1	1	1	2,5	2,5	2,5
Leiter mm <sup>2</sup> max	2,5	2,5	2,5	6	6	6